

SITUACIÓN
Calle Progreso 47 | 46003 | Valencia

REFERENCIA CATASTRAL | 9720622YJ2791H
Hoja | YJ2791H
Manzana | 97206
Parcela urbana | 22

CASA CABANYAL
Calle Progreso 47 | 46011 | El Cabanyal | VALENCIA
AUTOR
VIRUTA LAB

PREMIOS CERÁMICA 2023



PLANO SITUACIÓN

Nº REVISIÓN

ESCALA A1 1/5000 A3 1/10.000

PLANO Nº A.1.0.0



SITUACIÓN
Calle Progreso 47 | 46003 | Valencia

REFERENCIA CATASTRAL | 9720622YJ2791H
Hoja | YJ2791H
Manzana | 97206
Parcela urbana | 22

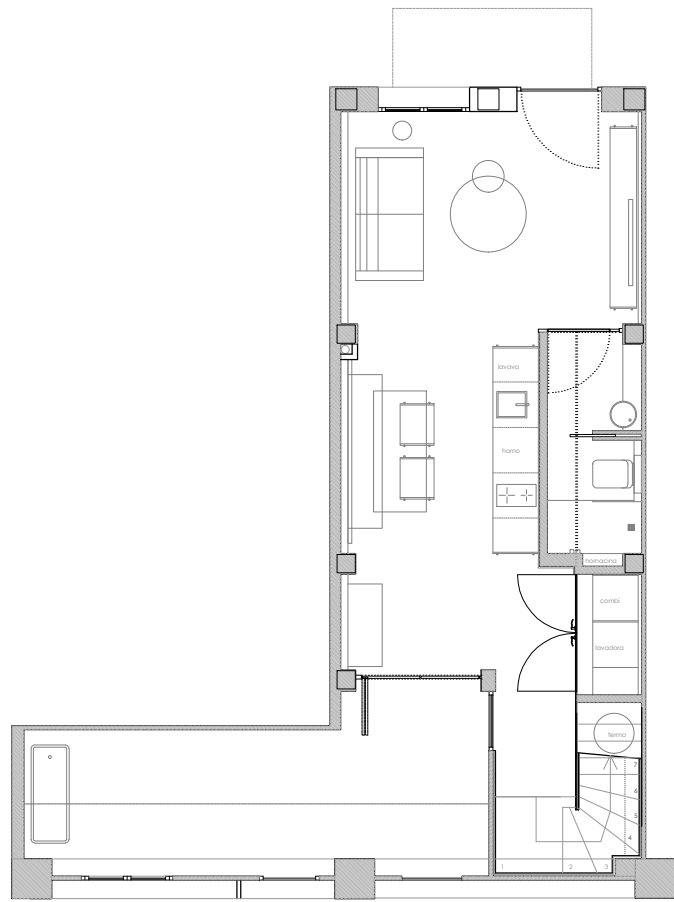

PLANTA BAJA



PLANTA PRIMERA



PLANTA CUBIERTA

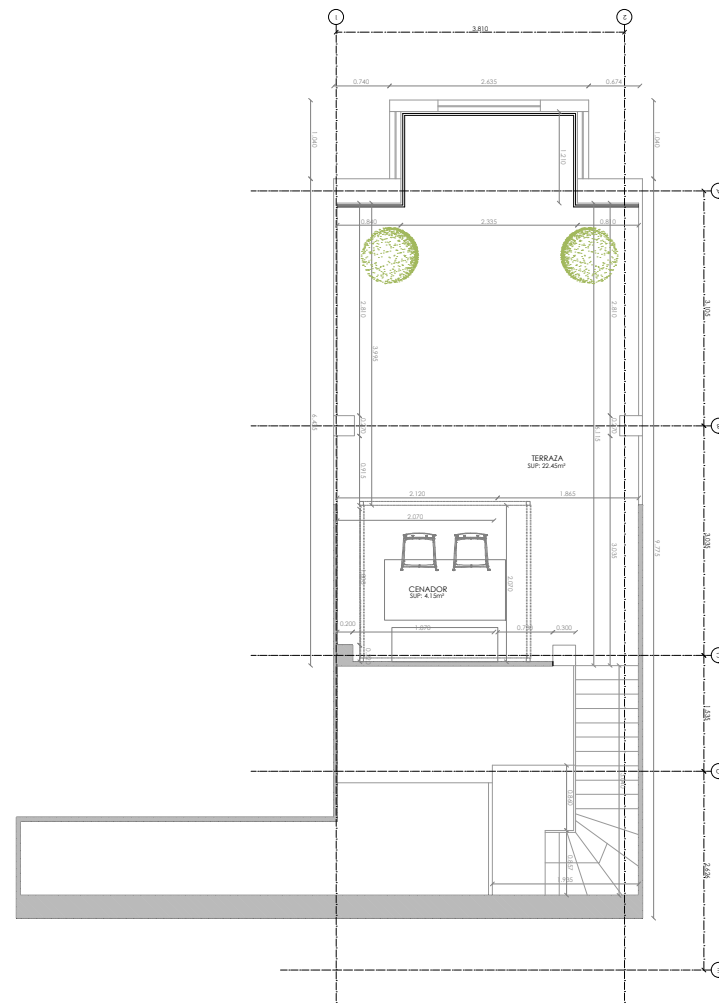
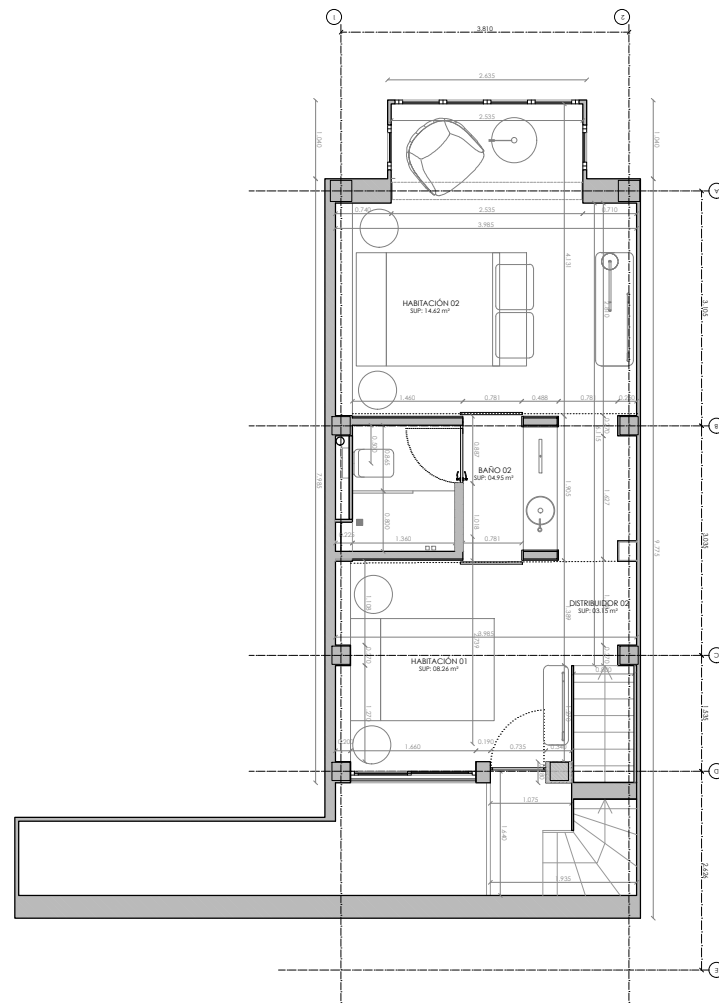
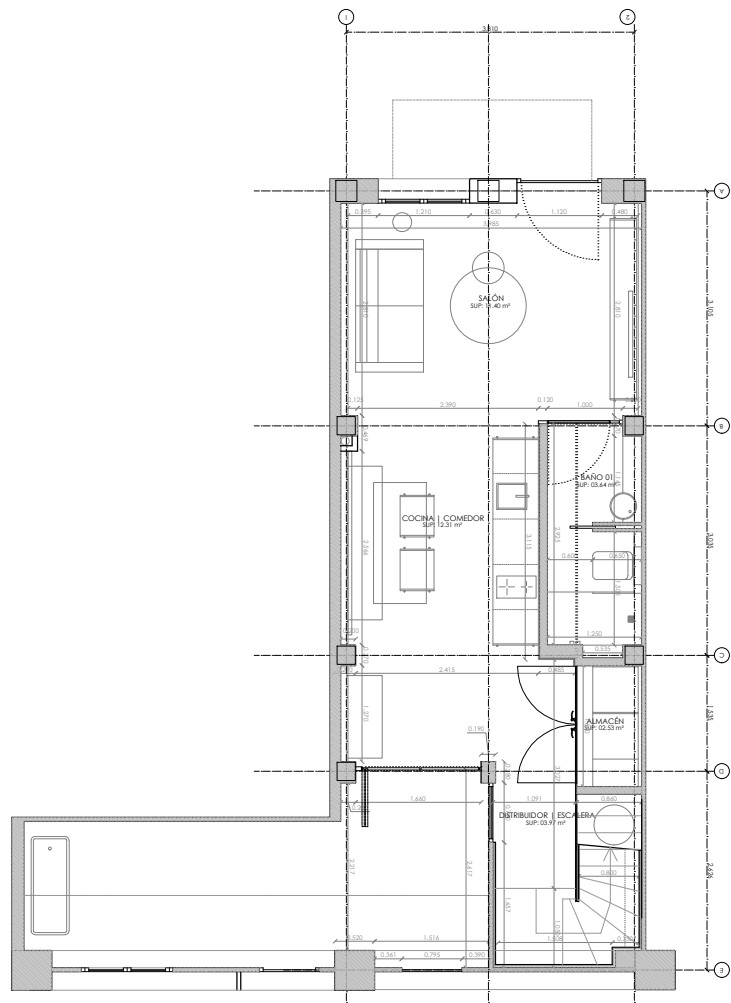

SUPERFICIE CONSTRUIDA	
PLANTA BAJA	38.97 m ²
PLANTA PRIMERA	35.95 m ²
PLANTA CUBIERTA	4.8 m ²
SUPERFICIE ÚTIL	
PLANTA BAJA	33.75 m ²
PLANTA PRIMERA	32.65 m ²
PLANTA CUBIERTA	4.15 m ²
ESPACIOS EXTERIORES	
PATIO PLANTA BAJA	4.81 m ²
ARRANQUE ESCALERA PD	2.43 m ²
TERRAZA	22.49 m ²

CUADRO DE SUPERFICIES

CASA CABANYAL
Calle Progreso 47 46011 El Cabanyal VALENCIA
AUTOR VIRUTA LAB

PREMIOS CERÁMICA 2023



ALZADO PRINCIPAL
ESTADO ACTUAL



ALZADO PRINCIPAL
ESTADO ACTUAL | DESVIRTUADO



ALZADO PRINCIPAL
ESTADO REFORMADO

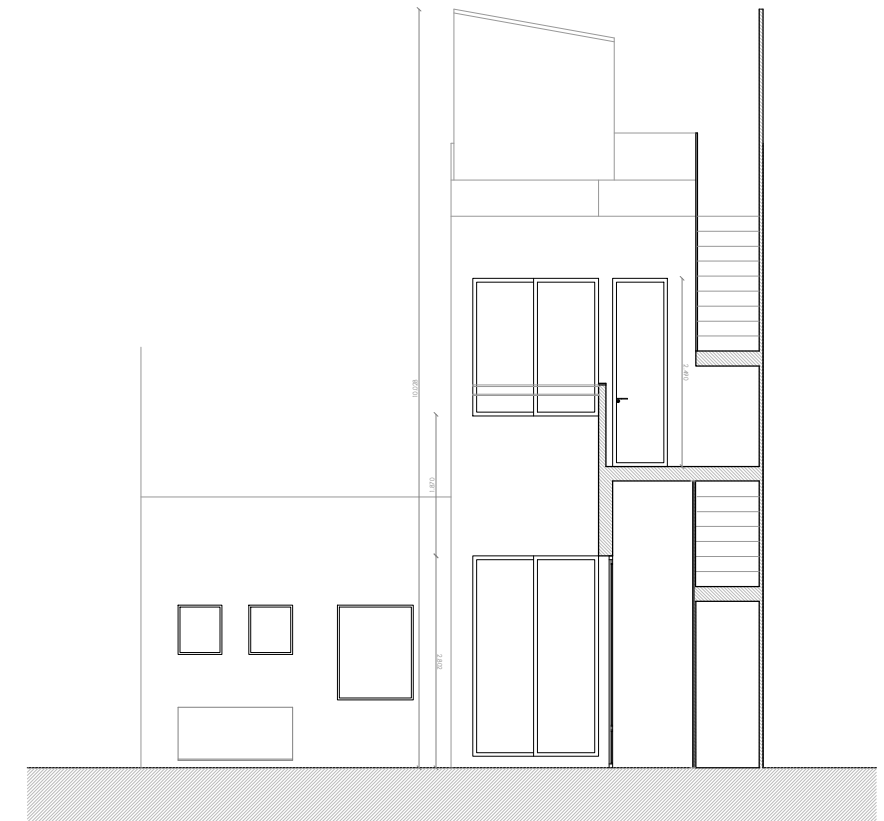

SECCIÓN a-a'
ALZADO 03

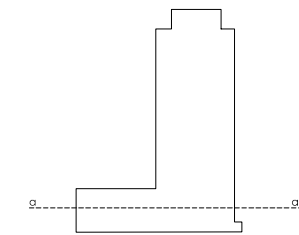

ACTUACIONES FACHADA PRINCIPAL

- Consolidación de los paramentos verticales
- Mortero bicapa a 2 colores (a determinar por DF) acabado paletado (yeso negro)
- Zócalo sobresaliente realizado en piedra caliza (90x30 cm)
- Recuperación de las carpinterías de madera en acabado nogal claro
- Recuperación, reparación, tratamiento, pintado y colocación de la cerrajería existente
- Suplementos de barandillas metálicas sección rectangular y lacadas a horno acabado texturizado
- Numeración fachada con perfil metálico sección circular y lacado a horno, acabado texturizado

ACTUACIONES FACHADAS SECUNDARIAS

- Consolidación de los paramentos verticales
- Mortero monocapa a 1 color (a determinar por DF) acabado paletado (yeso negro)
- Colocación de carpinterías de madera en acabado nogal claro
- Suplementos de barandillas metálicas sección rectangular y lacadas a horno acabado texturizado

CASA CABANYAL
Calle Progreso 47 46011 El Cabanyal VALENCIA

PREMIOS CERÁMICA 2023

AUTOR VIRUTA LAB



VIRUTA LAB



MARIA DÍAZ FELNER
ARQUITECTA COLEGIADA



DAVID PUERTA MENDOZA
ARQUITECTO COLEGIADO

PLANO ALZADOS

Nº REVISIÓN

ESCALA 1/50 A1 1/100 A3

PLANO Nº

A.4.0.0

LABORATORIO CREATIVO DE ARQUITECTURA E INTERIORISMO, CALLE DEL MAR 47, 46003, VALENCIA, TEL 630 367 506 / 617 906 856

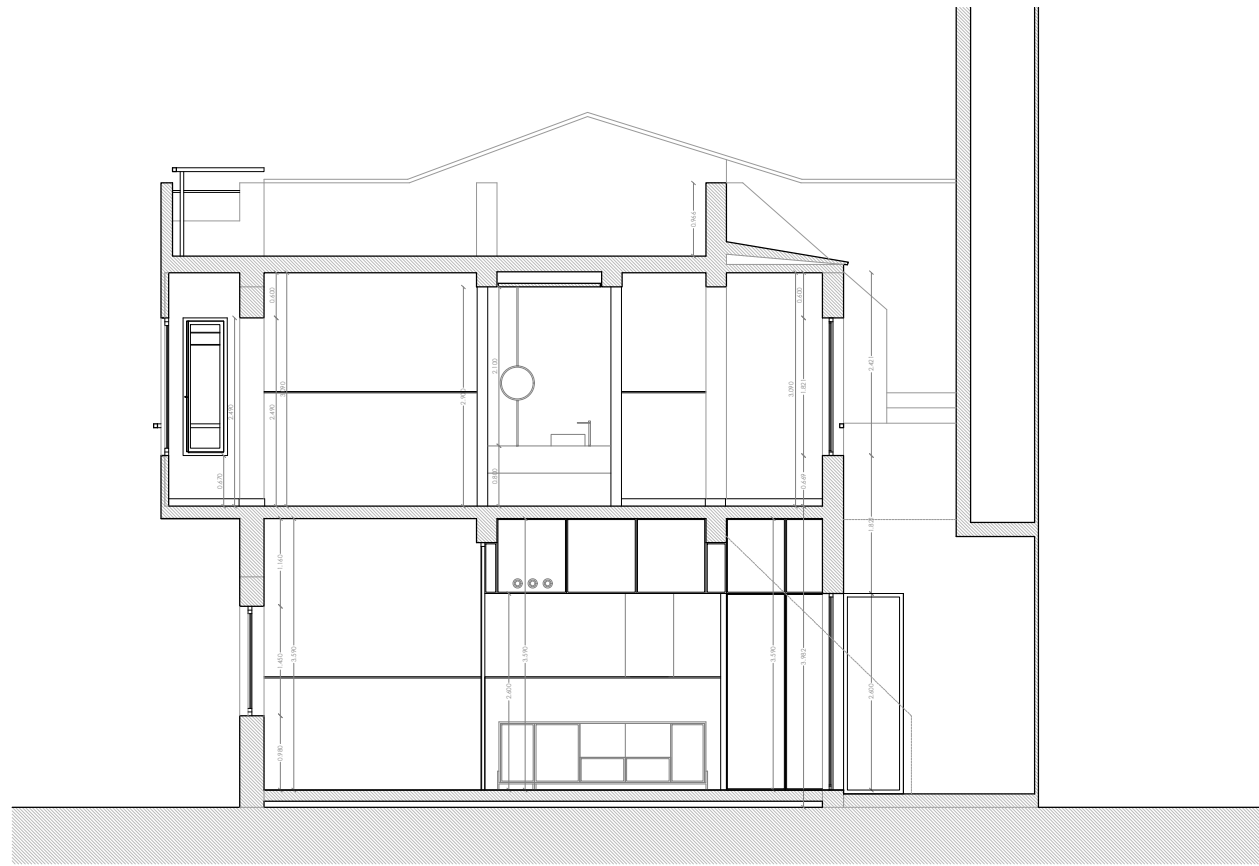

SECCIÓN VIVIENDA b-b'

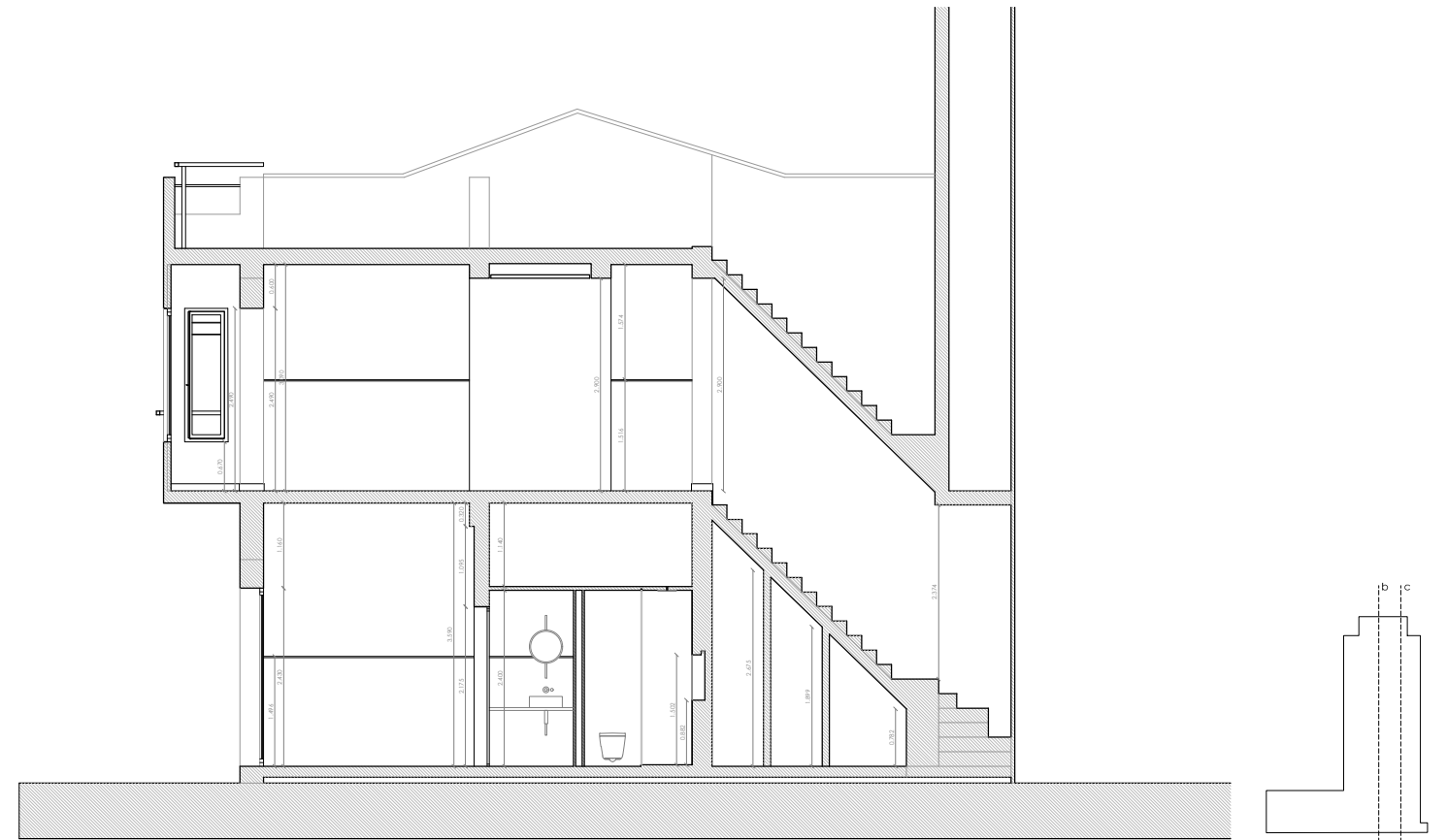

SECCIÓN VIVIENDA c-c'

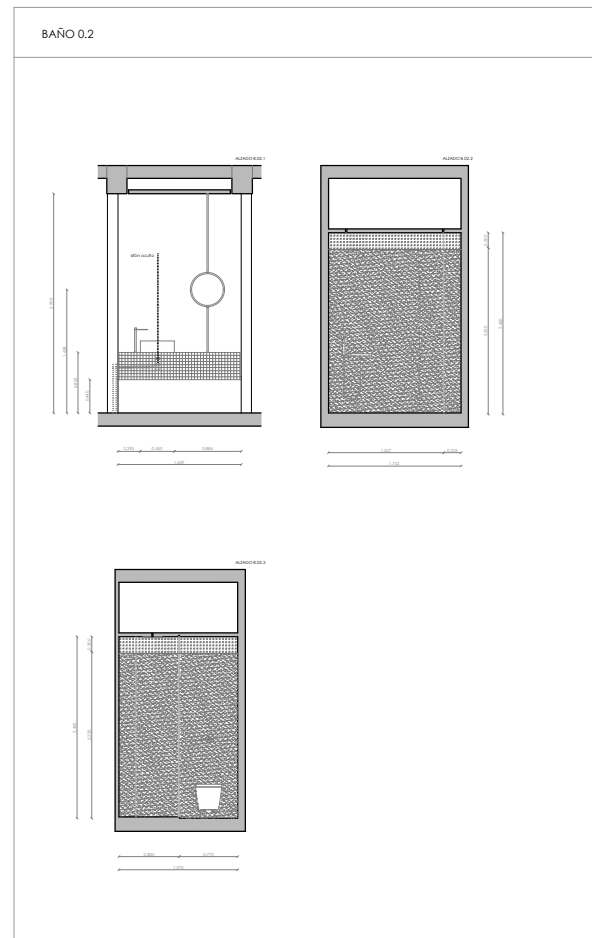
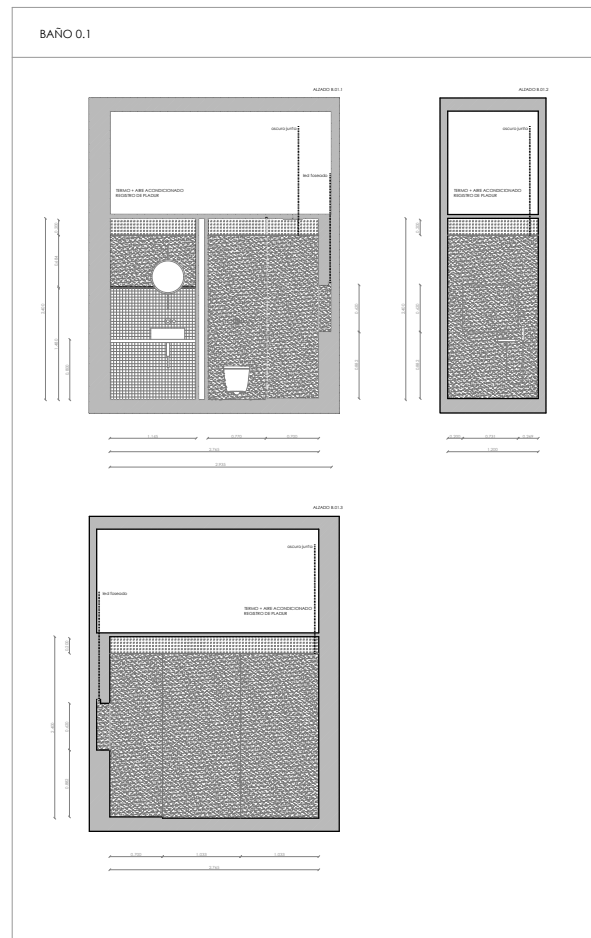

SECCIONES INTERIORES BAÑOS

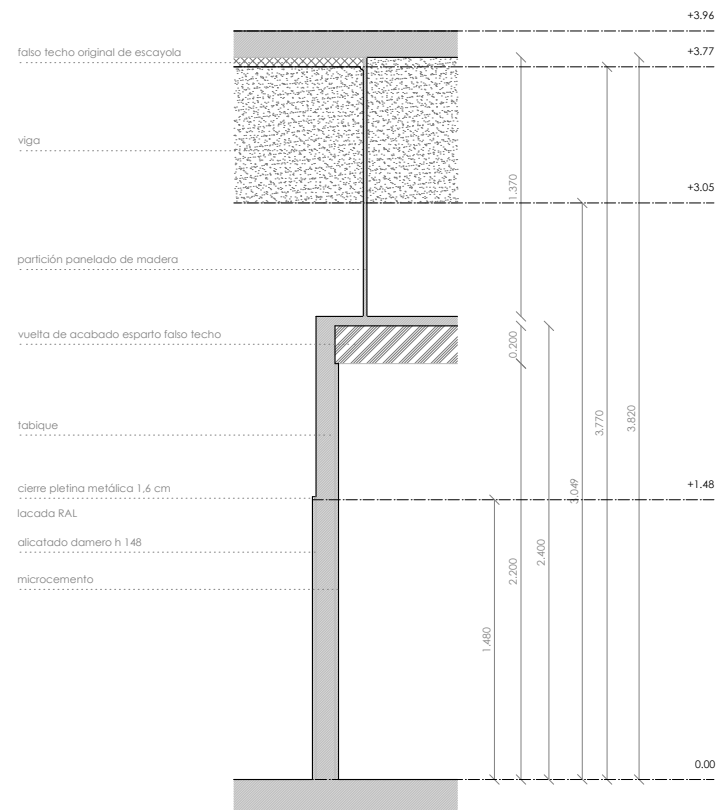

DETALLE 01 PARED COCINA | BAÑO
1/20 A1 1/40 A3

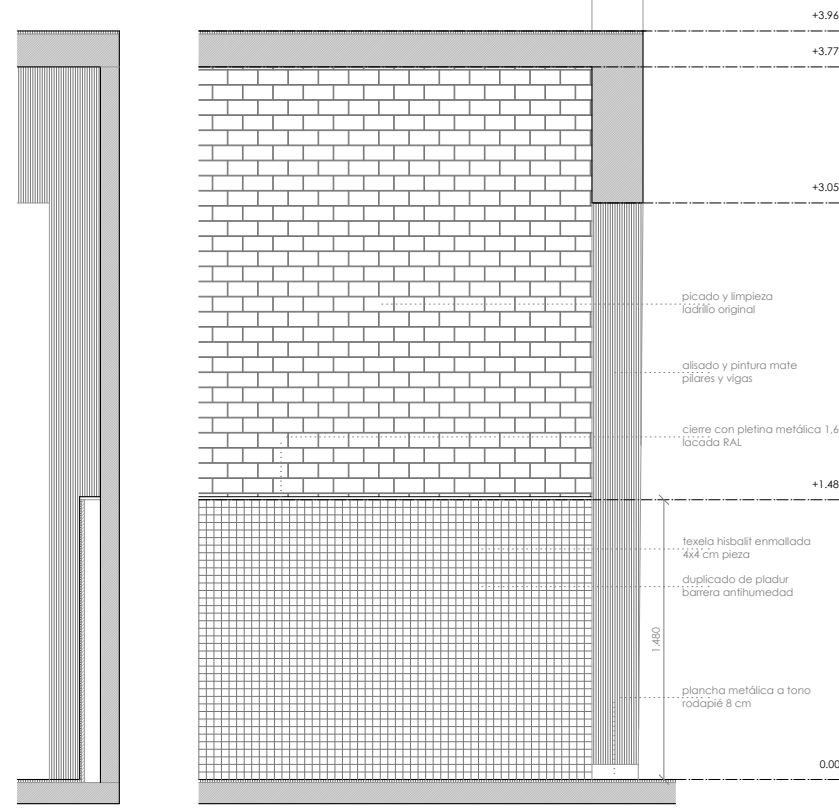

DETALLE 02 PARED TIPO
1/20 A1 1/40 A3

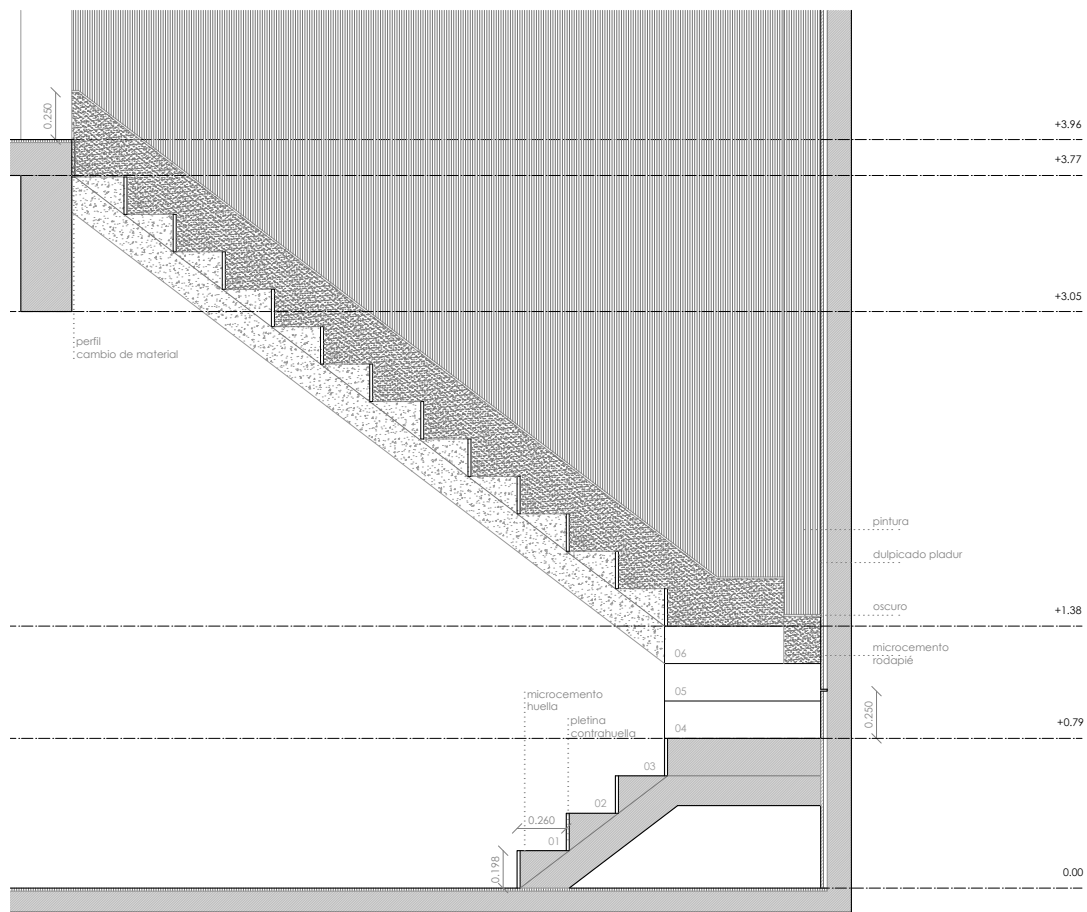

DETALLE 03 ESCALERA
1/20 A1 1/40 A3

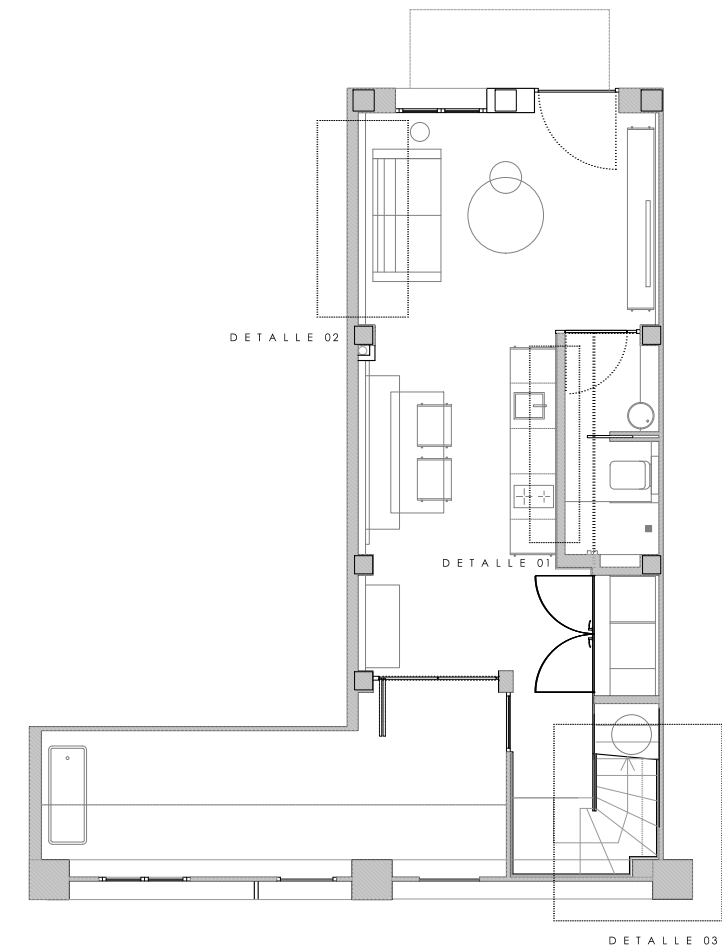
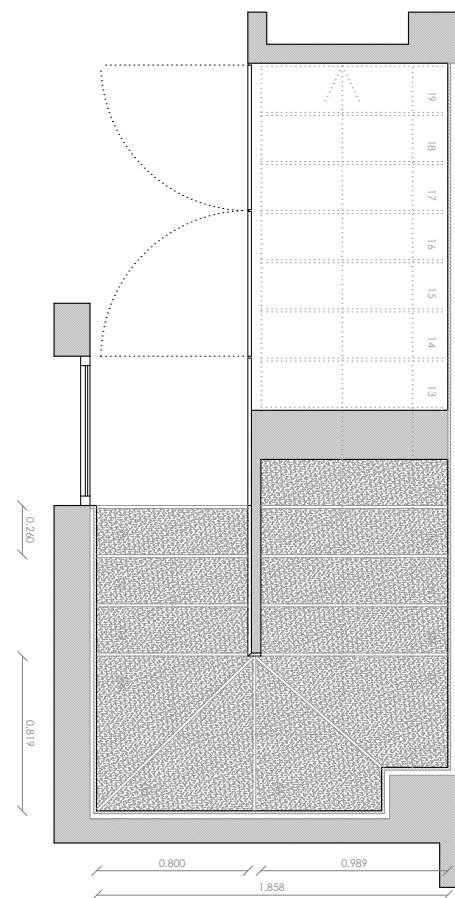

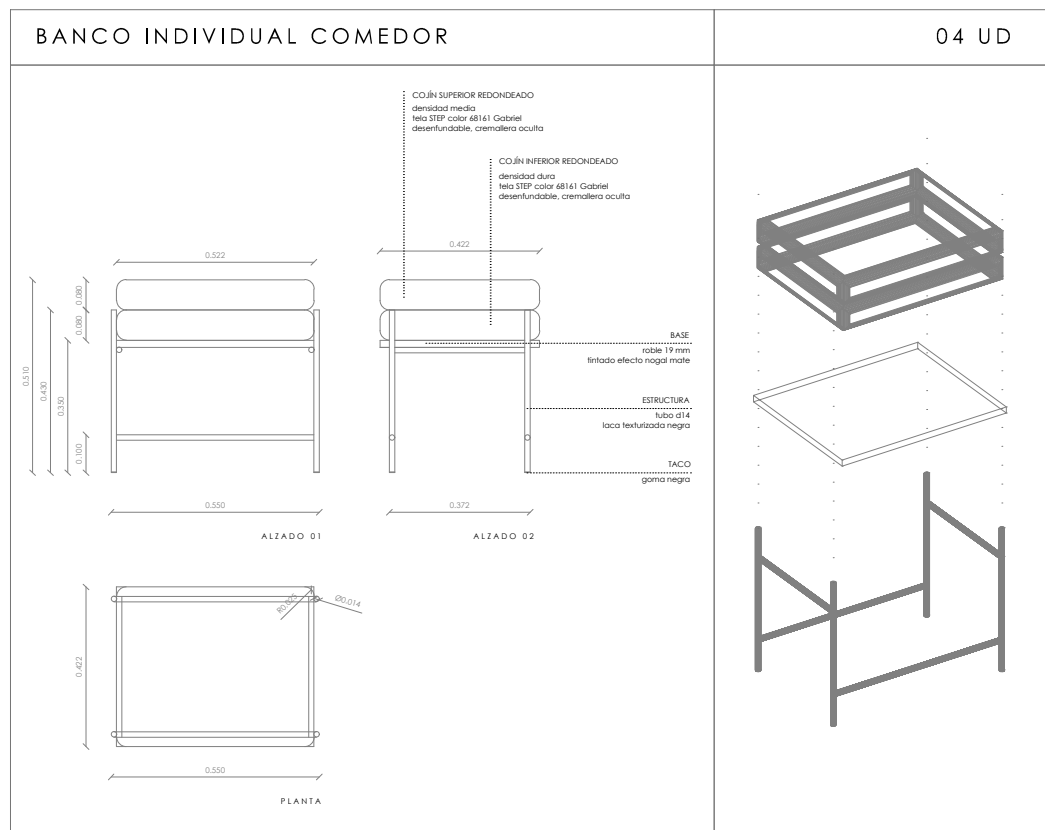

COJINES

TAPA MADERA

ESTRUCTURA

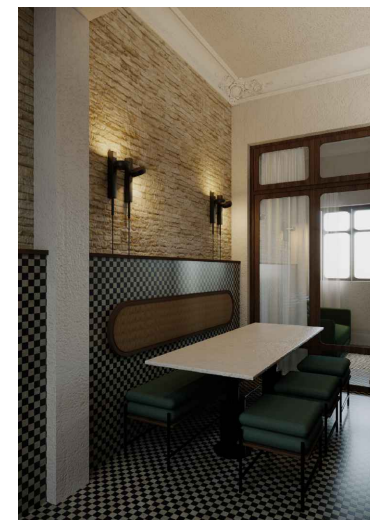

COMEDOR

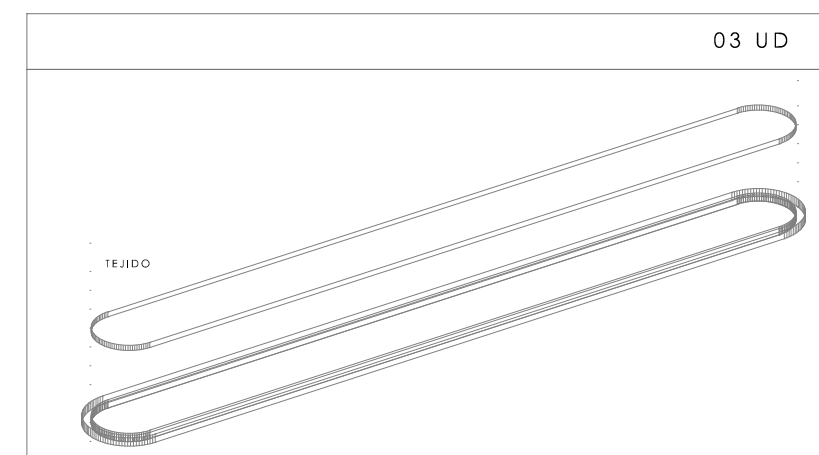
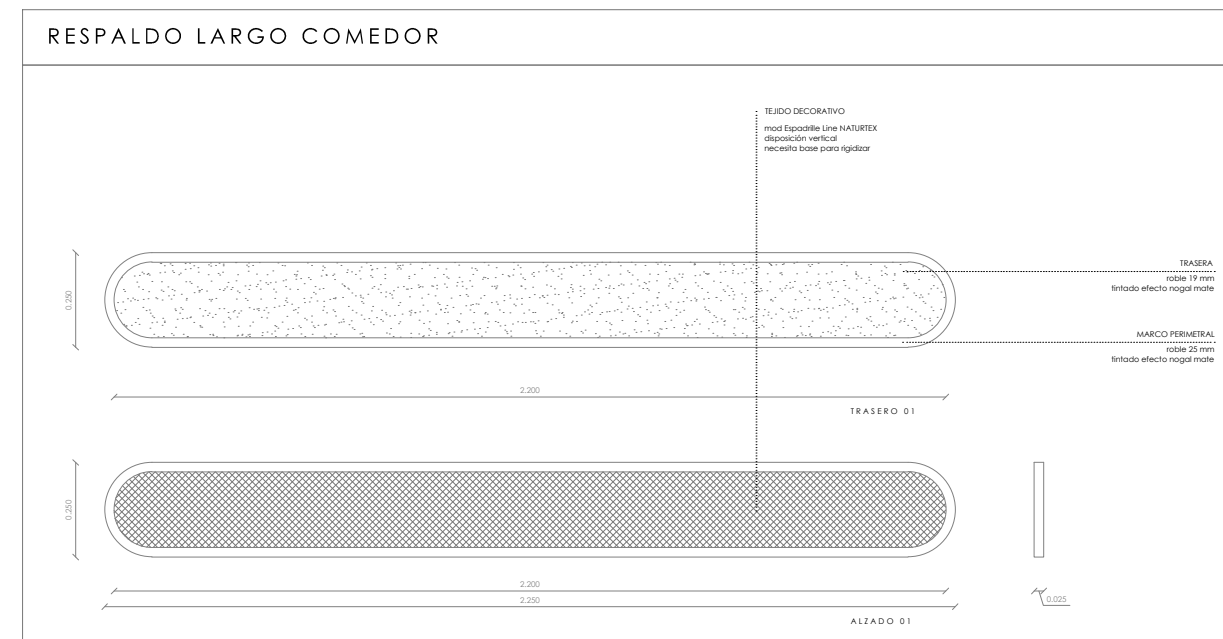

COJINES

TAPA MADERA

ESTRUCTURA

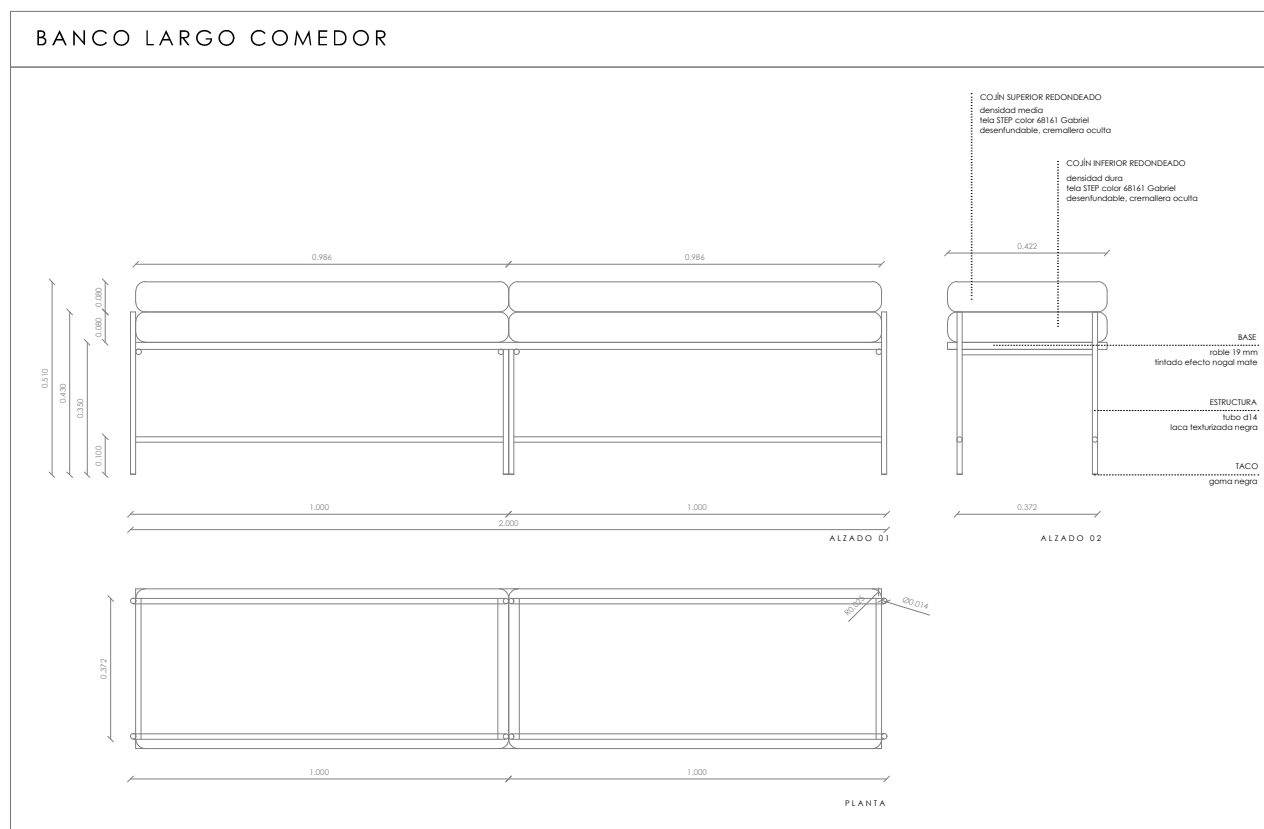

01 UD

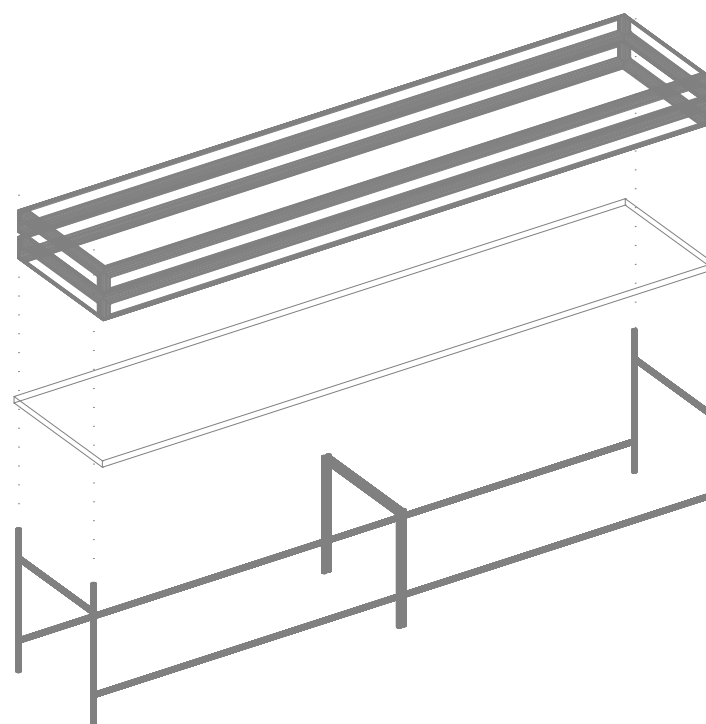

COJINES

TAPA MADERA

ESTRUCTURA

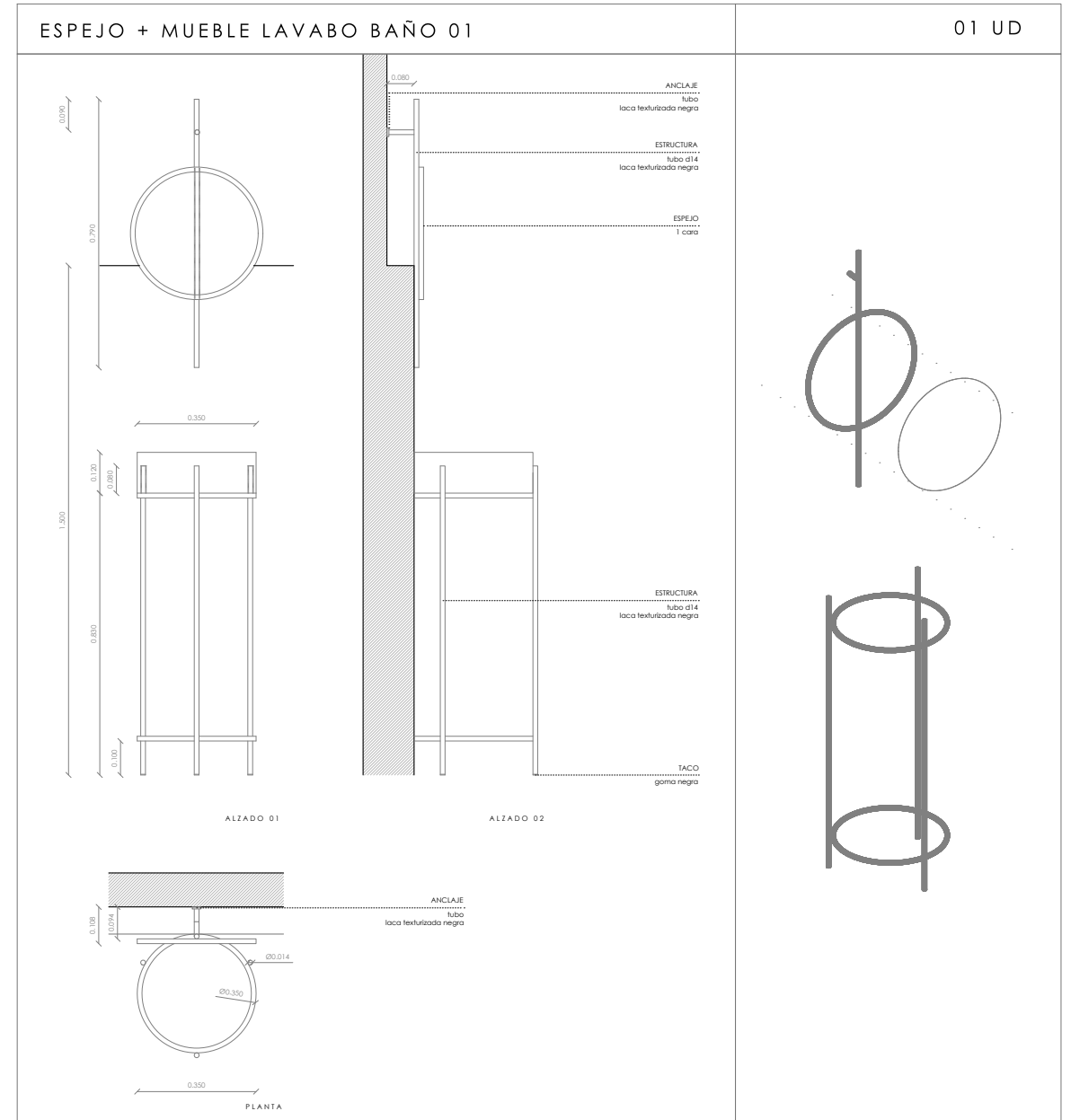
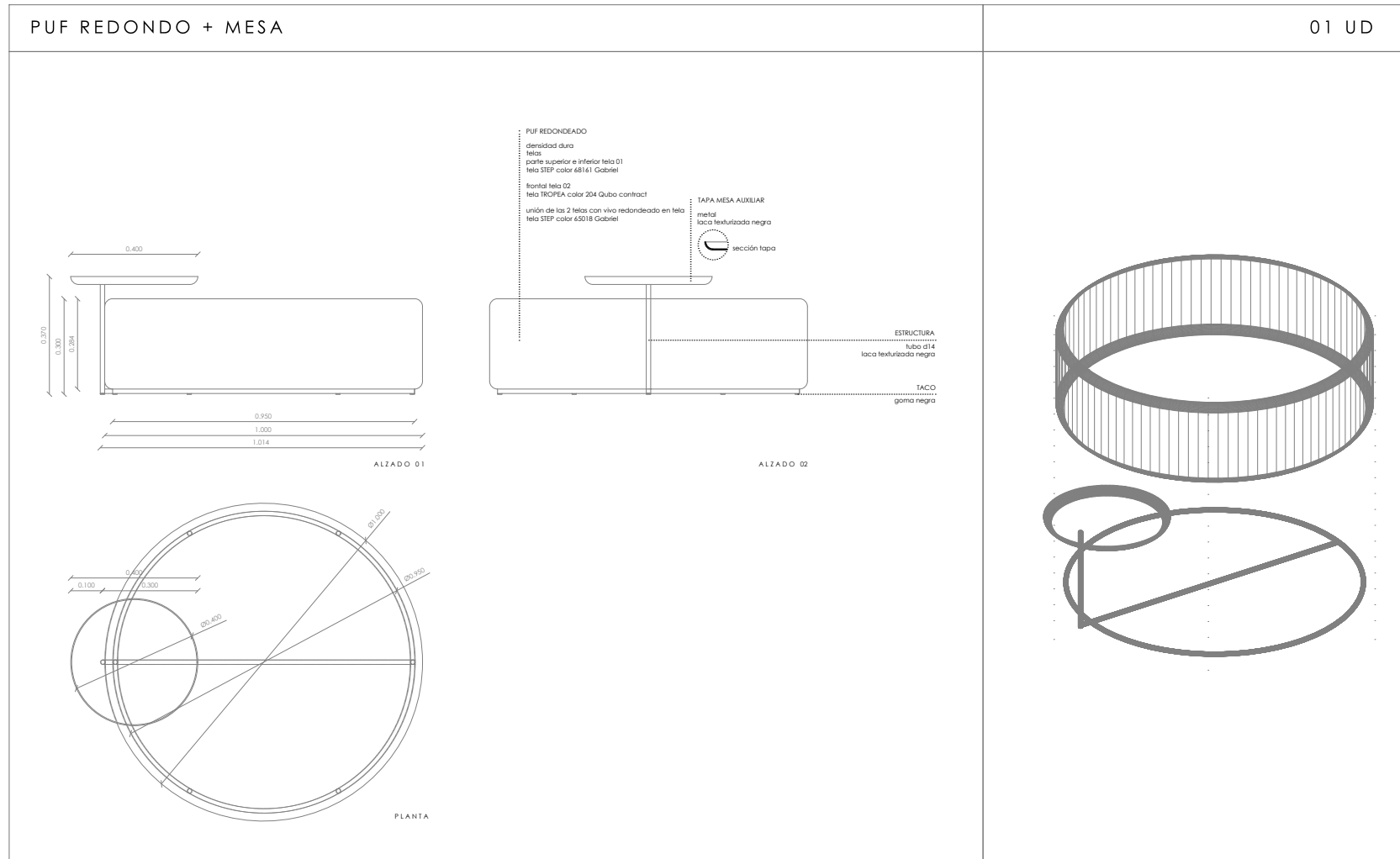

ESTRUCTURA 02

ESPEJO

ESTRUCTURA 01

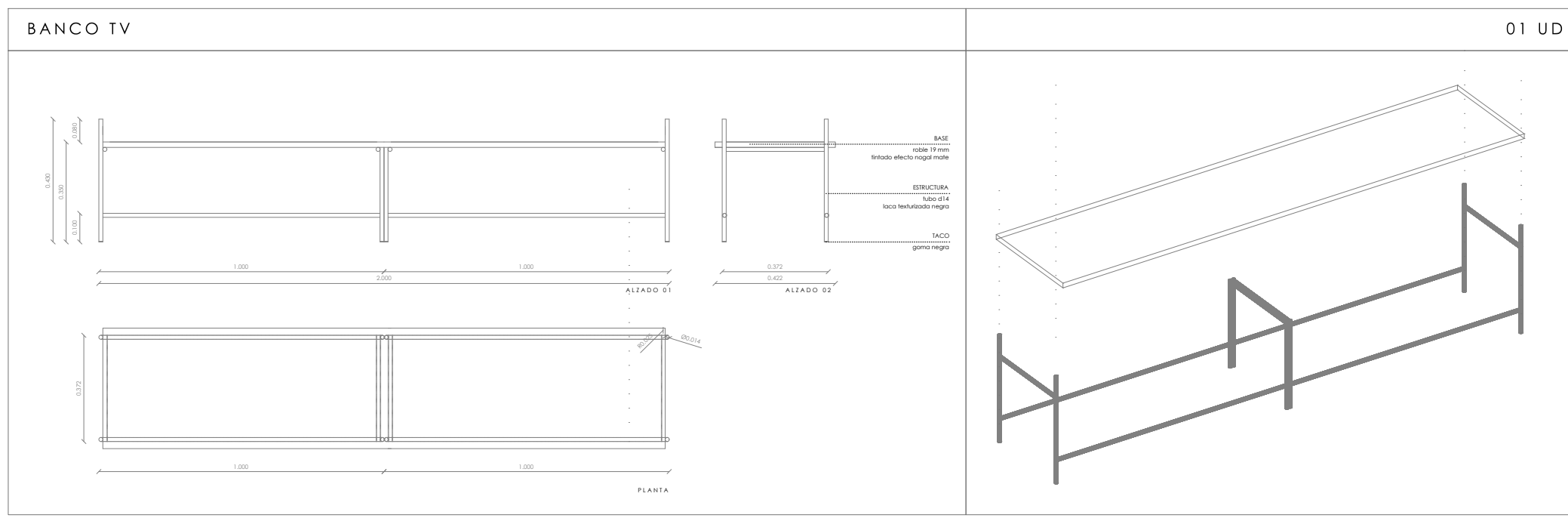

TAPA MADERA

ESTRUCTURA



BAÑO 02

SALÓN